

AIR NOZZLES AND JETS

Superior designed Air Nozzle and Jets reduce compressed air consumption and noise levels while maintaining Laminar Flow for Strong Blowoff

WHAT ARE THEY - REASONS TO USE

Air Nozzles are the smallest air amplifiers for point applications. There are two types: and aspirator or coned shaped type and so-called star-shaped profiles. The aspirator types provide greater flow amplification, ideal for cooling but have a lower force/air consumption ratio than star-shaped versions. So when higher force is more important, the star profile versions are the best choice.

Air Jets entrain large volumes of surrounding air through the Jet (similar to air amplifiers) and are more efficient than Air Nozzles because of their larger size. The larger the “air amplification nozzle or jet” the greater the efficiency for flow amplification although larger star profile nozzles can give a higher force/air consumption ratio.

The most important reasons to use Air Amplification Nozzles and Jets apart from energy reduction is safety and reduced noise levels. All Nex Flow™ Air Nozzles and Jets meet OSHA standard CFR 1910.242 (b) for dead end pressure. Noise levels are dramatically reduced up to 10dBA along with lower energy consumption.



The Nex Flow™ Air Mag™ “patent pending” star profile air amplifying nozzle has the best force/air consumption ratio known. Ideal when higher force required in blowoff applications.

Nex Flow™ Nozzles and Jets: Our range of nozzles can address most valid applications for blowoff and cooling.

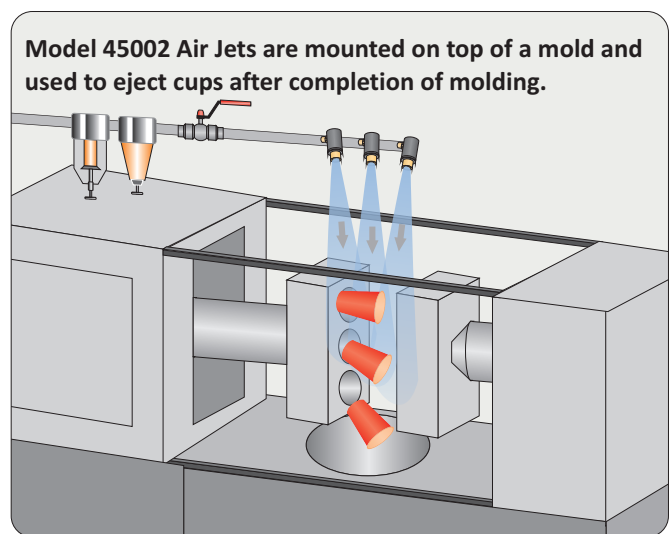
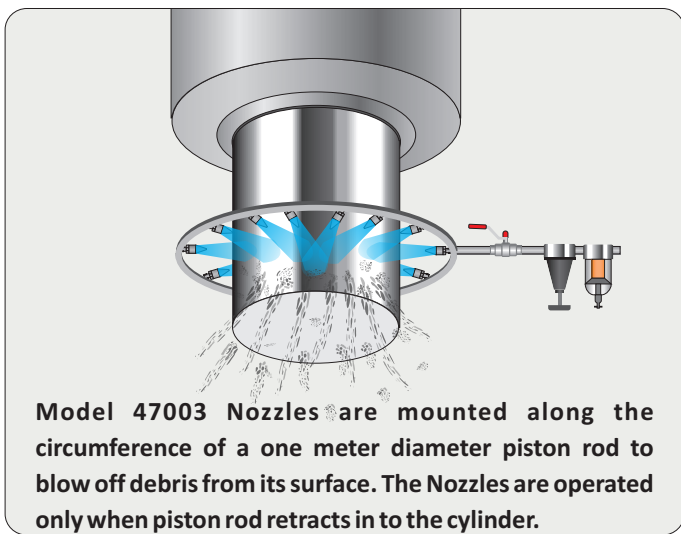

HOW IT WORKS

Air Mag™ Nozzle Model 47004AMF – Compressed air enters at point (A). Surrounding air (B) is entrained over the specially designed surface profile as the small amount of compressed air exits the specially designed holes drilled in the nozzle and combines at (C) to form a concentrated high velocity, laminar flow stream of amplified air flow and concentrated force with very high ratio of force/cfm.

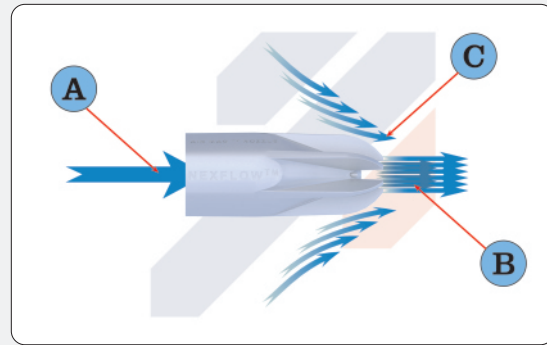

HOW IT WORKS

Air Nozzle - Models 47001, 47002, 47003, 47003S, 47003S-316L, 47004, 47004S, 47004S-316L, 47009, 47009S, 47009S-316L Compressed air enters at point (A). Surrounding air (B) is entrained over a specially designed profile surface by the action of the small amount of compressed air leaving the ring gap at point (C). This results in a concentrated high velocity, laminar flow stream of amplified air with maximized force.

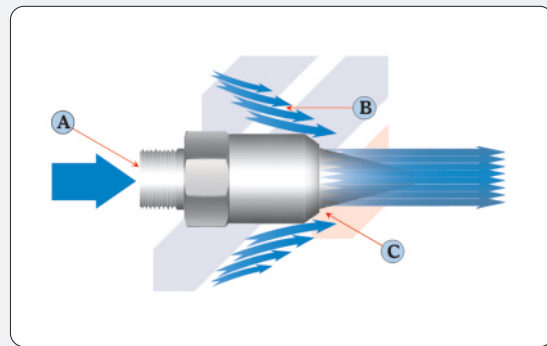

HOW IT WORKS

X-stream™ Air Nozzle - Model 47010 - Compressed air enters at point (A). Surrounding air (B) is entrained over a specially designed profile surface by the action of the small amount of compressed air leaving the small drilled holes at point (C). This results in a concentrated high velocity, laminar flow stream of amplified air with maximized force.

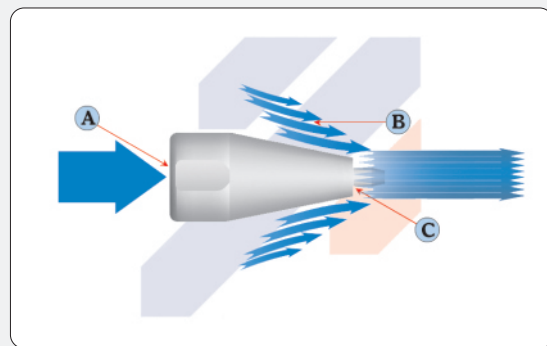

AIR NOZZLES

PART NO.	DESCRIPTION
47004AMF	Cast Zinc high force/air consumption efficiency Air Mag™ nozzle - 1/4" female NPT or BSP
47001	Brass Mini Nozzle with 10/32 fitting or metric equivalent
47002	Brass Mini Nozzle with copper tube - male
47003	Standard Aluminum 1/8" NPT or BPS male fitting
47003S	Standard 303/304 Stainless Steel 1/8" NPT or BPS male fitting
47003S-316L	Standard 316L Stainless Steel 1/8" NPT or BPS male fitting
47004	Extra Strong Aluminum 1/4" NPT or BPS male fitting
47004S	Standard 303/304 Stainless Steel 1/4" NPT or BPS male fitting
47004S-316L	Standard 316L Stainless Steel 1/4" NPT or BPS male fitting
47009	Adjustable Aluminum Nozzle with 1/8" male NPT or BPS fitting
47009S	Standard 303/304 Stainless Steel 1/8" NPT or BPS male fitting
47009S-316L	Standard 316L Stainless Steel 1/8" NPT or BPS male fitting
47010	X-Stream™ Anodized Aluminum Strong Force Nozzle with 1/4" female NPT or BPS fitting

THE NEX FLOW™ AIR MAG™ NOZZLES

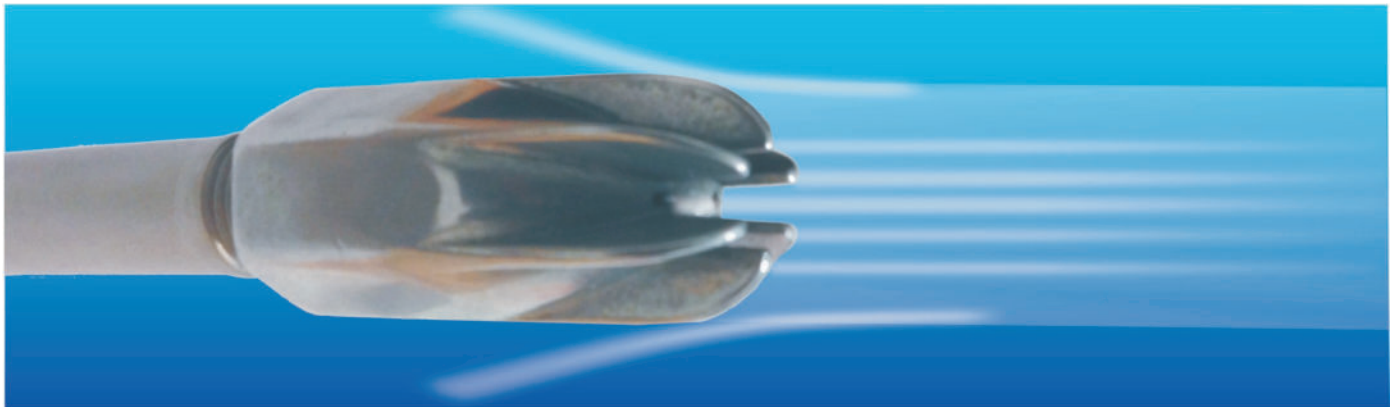

The “Patent Pending” **NEX FLOW™ AIR MAG™ NOZZLE** is extremely efficient in producing a higher force/unit of air consumption because of its unique design utilizing small diameter air exit holes to concentrate the air flow from the other holes, along with entrained air to produce a high force at the target. This design also extends the distance for laminar flow allowing greater flexibility in use at a distance. It even out performed so-called laval type nozzles and does not have the annoying whistling sound that might occur with such designs.

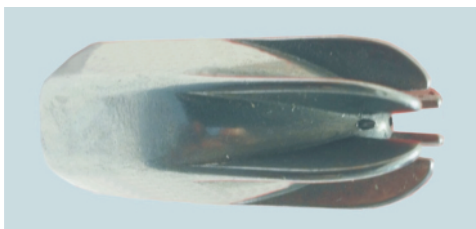

Model 47004AMF – is the first product of the **The Nex Flow™ Air Mag™** “patent pending” star profile air amplifying nozzle and has the best force/air consumption ratio known. Ideal when higher force required in blowoff applications.

Sound Level 74 dBA at 3 ft. (0,91m) at 80 psig (5.5 bar)

HOW TO PROVE FOR YOURSELF HOW GOOD A NOZZLE IS?

The Nex Flow™ Air Mag™ nozzle is designed so that the force at a particular pressure will be approximately the same as competitive nozzle of star type profile design. To compare and prove the superiority of the Nex Flow™ Air Mag™ nozzle this makes it easy by simply replacing the other nozzle and seeing what happens. To do this, have a pressure regulator and gauge upstream. And if possible a flow meter upstream. Either have a scale to blow against or just apply it your particular application. For each nozzle, adjust the pressure upstream to that it is the same for all nozzles tested. This is what you can expect.....

If you replace any competitive nozzle, you will probably have to cut back the pressure as you will get more force from the Nex Flow™ Air Mag™ nozzle. This is because the air consumption is “less” at any given pressure which also means less pressure drop in the line as the air flows out through the nozzle. So you will actually be getting a bit more pressure and force as a result. You can then cut back the pressure if not needed thereby reducing compressed air use even more.

If you have a flow meter, all nozzles can be tested comparatively.

Alternatively, you can just try the various nozzles and you will find the Nex Flow™ Air Mag™ nozzle to perform better simply because there is less pressure drop since it uses less compressed air, indicating its greater efficiency.



PERFORMANCE OF THE NEX FLOW™ MODEL 47004AMF AIR MAG™ NOZZLE

AIR MAG NOZZLE - 1/4" - MODEL: 47004AMF						
INLET PRESSURE PSIG (BAR)	20 (1.4)	40 (2.8)	60 (4.1)	80 (5.5)	100 (6.9)	120 (8.3)
FORCE LBS (GRAMS)	0.247 (112)	0.474 (215)	0.705 (320)	0.937 (425)	1.172 (532)	1.143 (519)
AIR CONSUMPTION SCFM (SLPM)	5.5 (156)	9.0 (255)	12.0 (340)	15.5 (439)	19.7 (558)	23.4 (663)

Note: Data for Force measured at 6"

**FORCE EFFICIENCY OF THE NEX FLOW™
MODEL 47004AMF AIR MAG™ NOZZLE
TO COMPETITIVE VERSIONS**

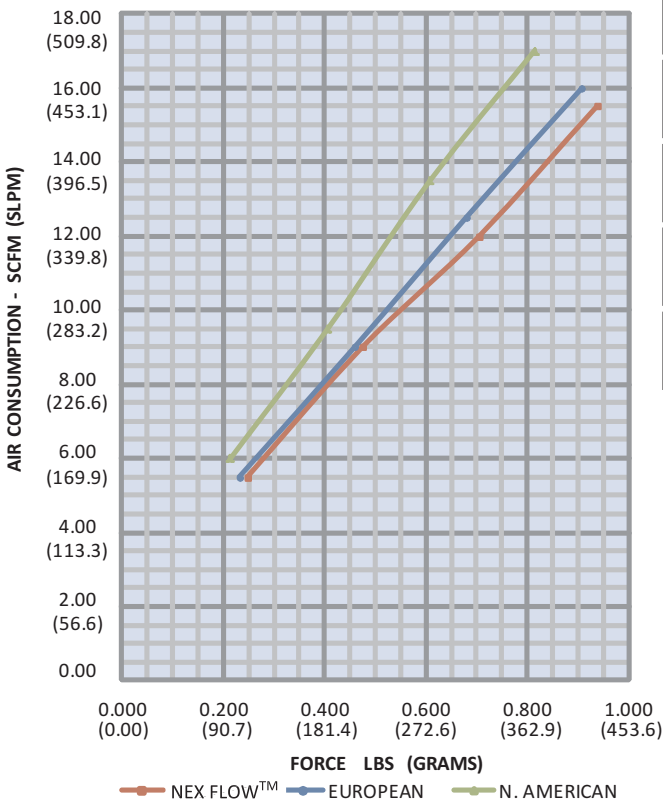

Note: Data for Force measured at 6". Data measurement was done at a college test laboratory utilizing accurate force and flow measurement equipment. All nozzles tested under the same conditions. Published data was not used – only actual measurements made in the lab.

INPUT LINE PRESSURE PSIG (BAR)	NEX FLOW™ AIR MAG™ NOZZLE		EUROPEAN STAR TYPE DESIGN		NORTH AMERICAN STAR TYPE DESIGN	
	Force-Lbs (Force-gms)	SCFM (SLPM)	Force-Lbs (Force-gms)	SCFM (SLPM)	Force-Lbs (Force-gms)	SCFM (SLPM)
40 (2.8)	.474 (215)	9.0 (255)	.421 (191)	9.0 (255)	.421 (191)	9.5 (269)
60 (4.1)	.705 (320)	12.0 (340)	.637 (289)	12.5 (354)	.633 (287)	13.5 (382)
80 (5.5)	.937 (425)	15.5 (439)	.840 (381)	16.0 (453)	.840 (381)	17.0 (481)

Note: Data for Force measured at 6"

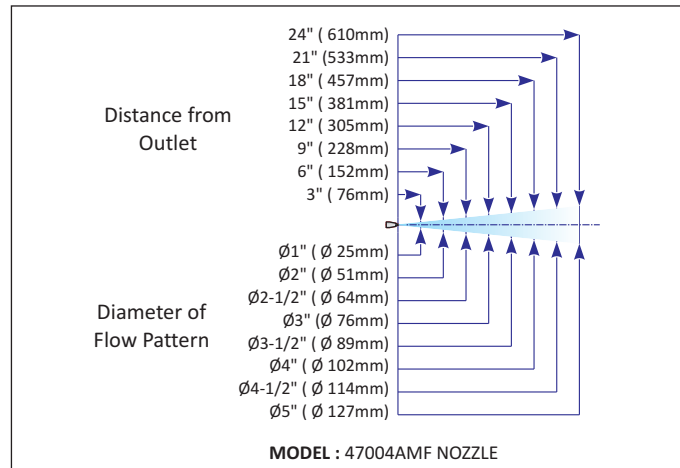

ADVANTAGES OF THE AIR MAG™ DESIGN

- . Lowest air consumption for force produced
- . lower noise levels
- . no whistling sound
- . single piece design for extra strength



AIR NOZZLES:

Nex Flow™ Nozzles are designed to fit into small spaces. We have an adjustable Nozzle for some applications and then a few different Nozzles with varying force, depending on the application.



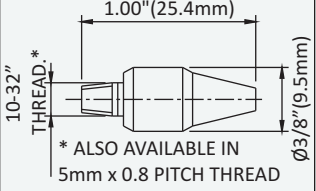

1.00" (25.4mm)
10-32" THREAD*
* ALSO AVAILABLE IN 5mm x 0.8 PITCH THREAD
Ø3/8" (9.5mm)

Model 47001 - Is a small brass Nozzle to fit into small spots and used by many machine builders for blowoff applications.
Sound level 74 dBA at 3ft (0.91mm) at 80 psig (5.6 bar).



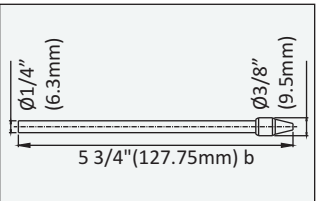

Ø1/4" (6.3mm)
5 3/4" (127.75mm) b
Ø3/8" (9.5mm)

Model 47002 - Is the small Model 47001 brass Nozzle added to a copper tube. Machine builders can bend the copper tube and aim the nozzles to where ever it suits. The copper tube is simply press fit into the customer's system.
Sound level 74 dBA at 3ft (0.91mm) at 80 psig (5.6 bar).

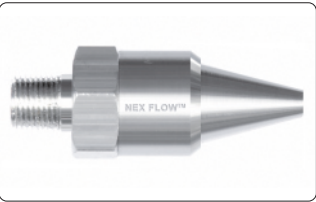

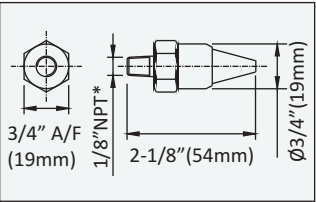

3/4" A/F (19mm)
1/8" NPT*
2-1/8" (54mm)
Ø3/4" (19mm)

Model 47003 (anodized aluminum), 47003S (303/304 stainless steel), 47003S-316L (316L stainless steel) -
Is a common standard strength nozzle with a 1/8" male NPT connection and ideal for most blow-off applications involving liquids. It is made of aluminum (or stainless steel) and is partially anodized for longer life. The coanda profile is made for excellent noise reduction and blow-off force at a good distance
Sound level 77 dBA at 3ft (0.91mm) at 80 psig (5.6 bar).



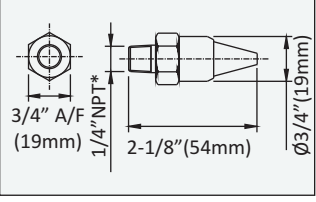

3/4" A/F (19mm)
1/4" NPT*
2-1/8" (54mm)
Ø3/4" (19mm)

Model 47004 (anodized aluminum), 47004S (303/304 stainless steel), 47004S-316L (316L stainless steel) -
Is another common but stronger force nozzles with a 1/4" male NPT connection and ideal for most blow-off applications involving liquids and even light weight parts. It is made of aluminum (or stainless steel) and is partially anodized for longer life. Again the coanda profile is made for excellent noise reduction and blow-off force at a good distance.
Sound level 78 dBA at 3ft (0.91mm) at 80 psig (5.6 bar).



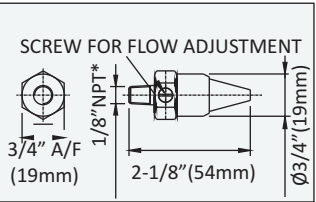

SCREW FOR FLOW ADJUSTMENT
3/4" A/F (19mm)
1/8" NPT*
2-1/8" (54mm)
Ø3/4" (19mm)

Model 47009 (anodized aluminum), 47009S (303/304 stainless steel), 47009S-316L (316L stainless steel) -
Is similar to the 47003 except it is made adjustable. The Superior design of the adjustable set screw is made to adjust the nozzles within its weakest and strongest ranges.

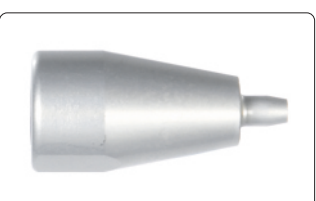

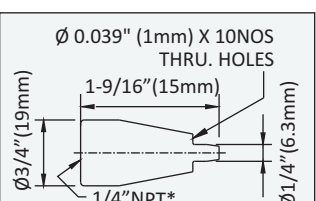

Ø 0.039" (1mm) X 10NOS THRU. HOLES
1-9/16" (15mm)
Ø3/4" (19mm)
1/4" NPT*
Ø1/4" (6.3mm)

Model 47010 - Is a unique design by Nex Flow™ and is extremely powerful. It has a 1/4" female NPT fitting and is fully anodized for long life. With the 'coanda' profile you get an extremely strong force at a distance. This is an ideal Nozzle for blow guns and for blowing small parts for part ejection heavier viscosity liquids. The 47010 is a higher force Nozzle but has less distance for laminar flow than the 47004. Use the Model 47004 is greater distance required from the Nozzle.
Sound level 78 dBA at 3ft (0.91mm) at 80 psig (5.6 bar).

*BSP Threads or Adaptors can be supplied depending on country location.

Air Consumption At Various Pressure for Model 47001 and 47002 Air Nozzles

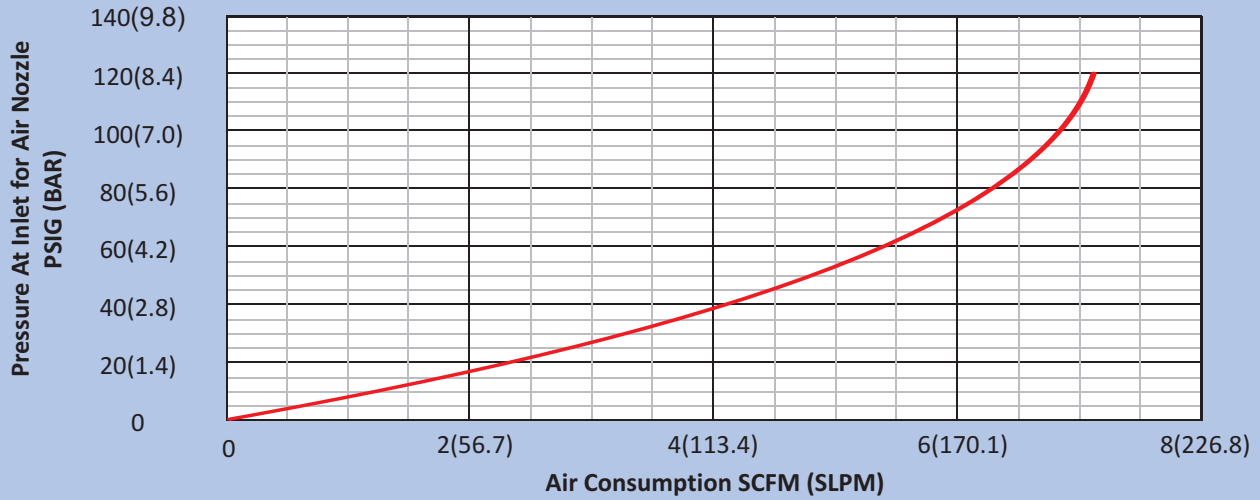

Force At Various Pressure for Model 47001 and 47002 Air Nozzles

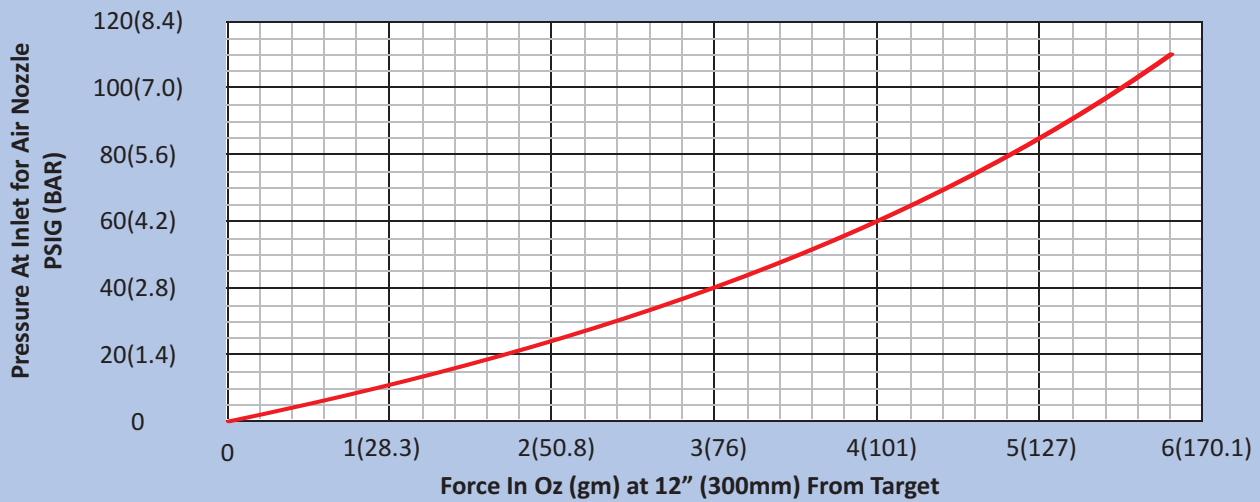

Air Consumption At Various Pressure for Model 47003, 47003S and 47003S-316L Air Nozzles.

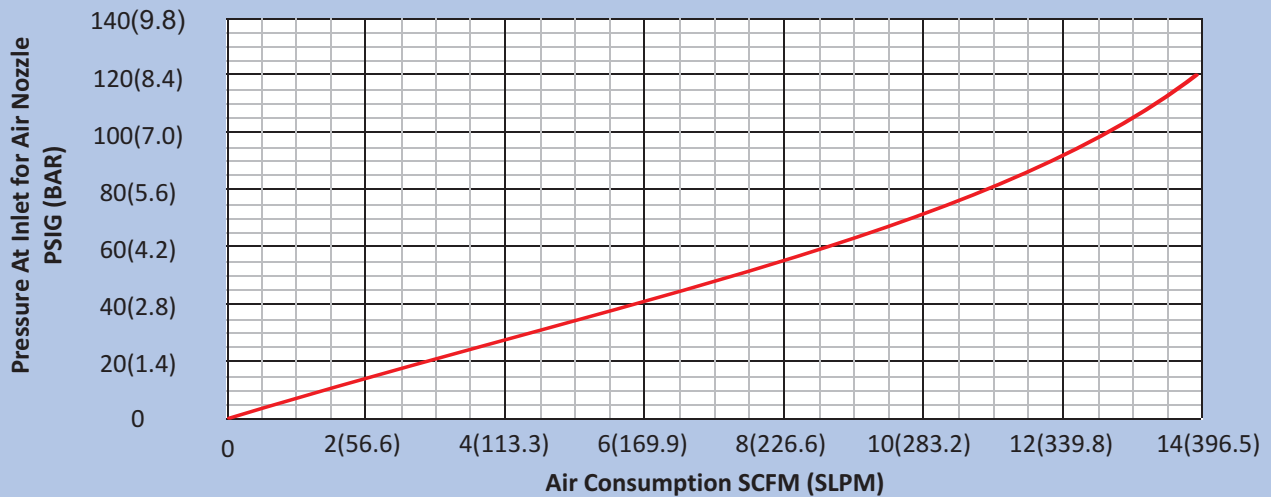

Force At Various Pressure for Model 47003, 47003S and 47003S-316L Air Nozzles.

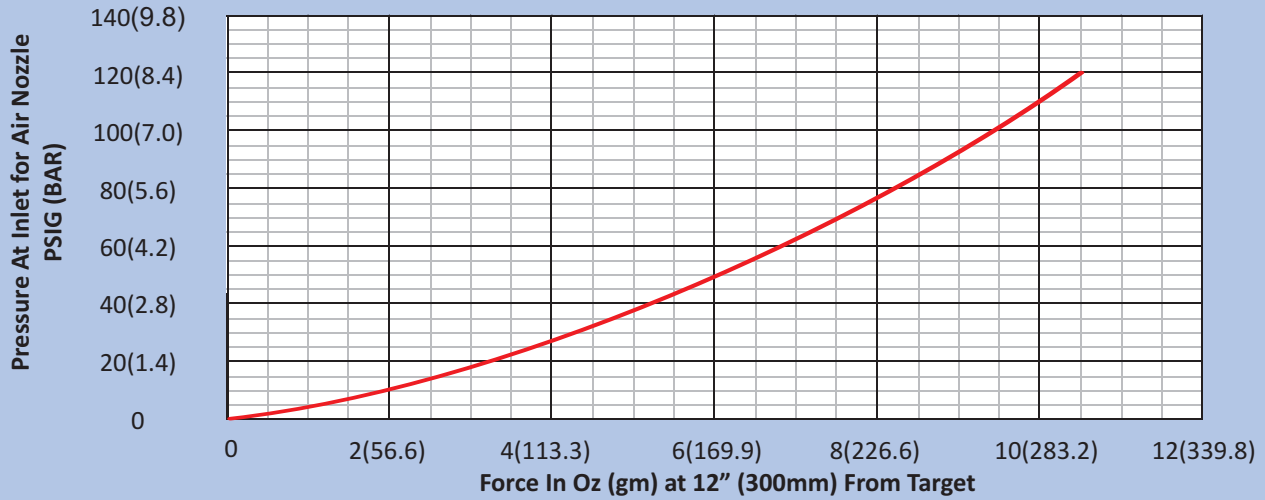

Air Consumption At Various Pressure for Model 47003, 47003S and 47003S-316L Air Nozzles.

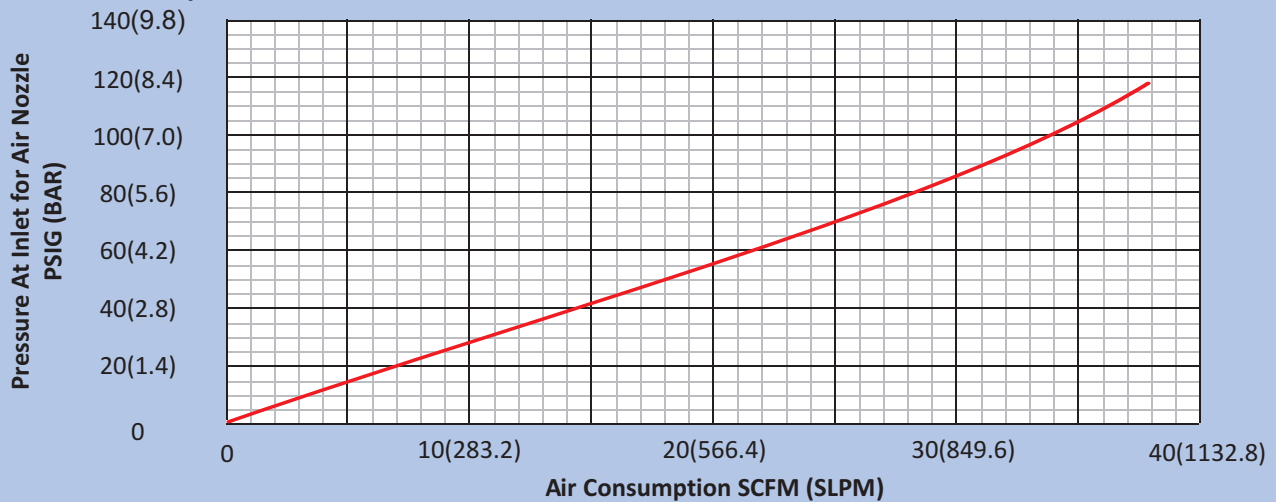

Force At Various Pressure for Model 47004, 47004S and 47004S-316L Air Nozzles.

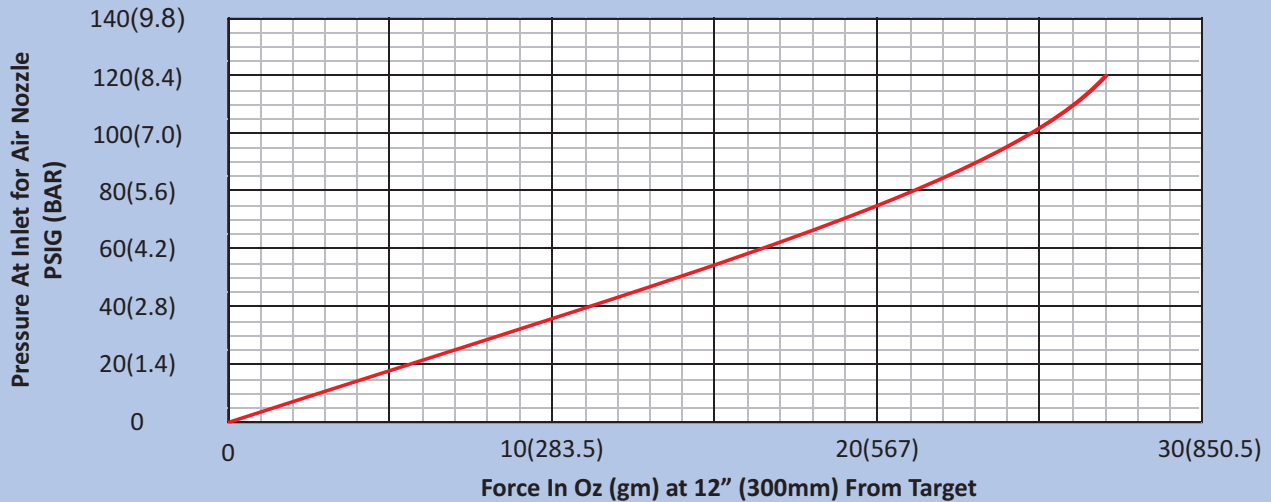

Air Consumption At Various Pressure for Model 47009, 47009S and 47009S-316L (Max Open condition)

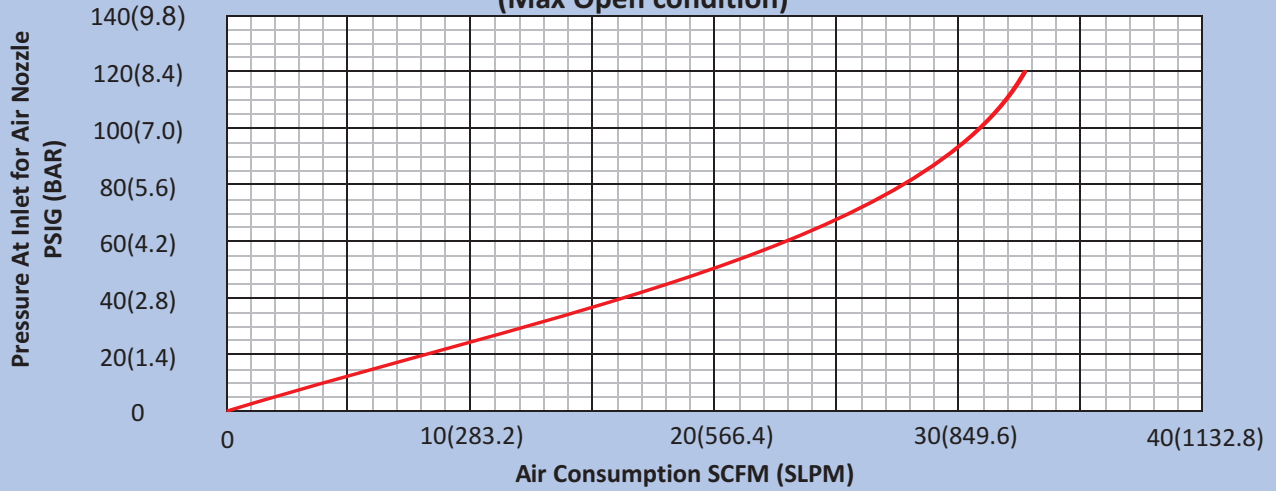

Force At Various Pressure for Model 47009, 47009S and 47009S-316L (Max Open condition)

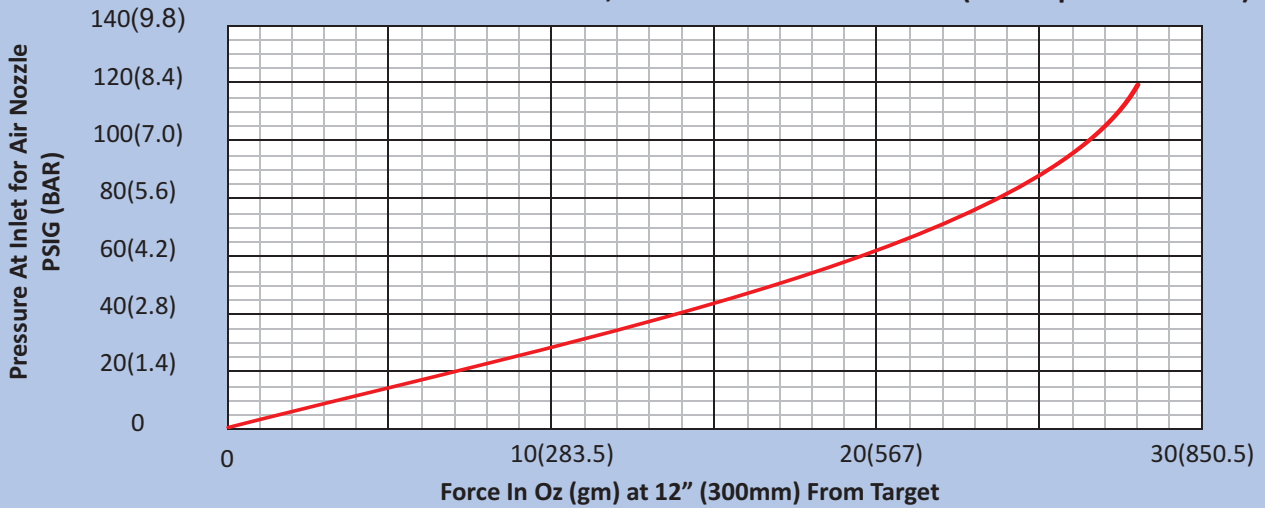

Air Consumption At Various Pressure for Model 47010 (10 Holes)

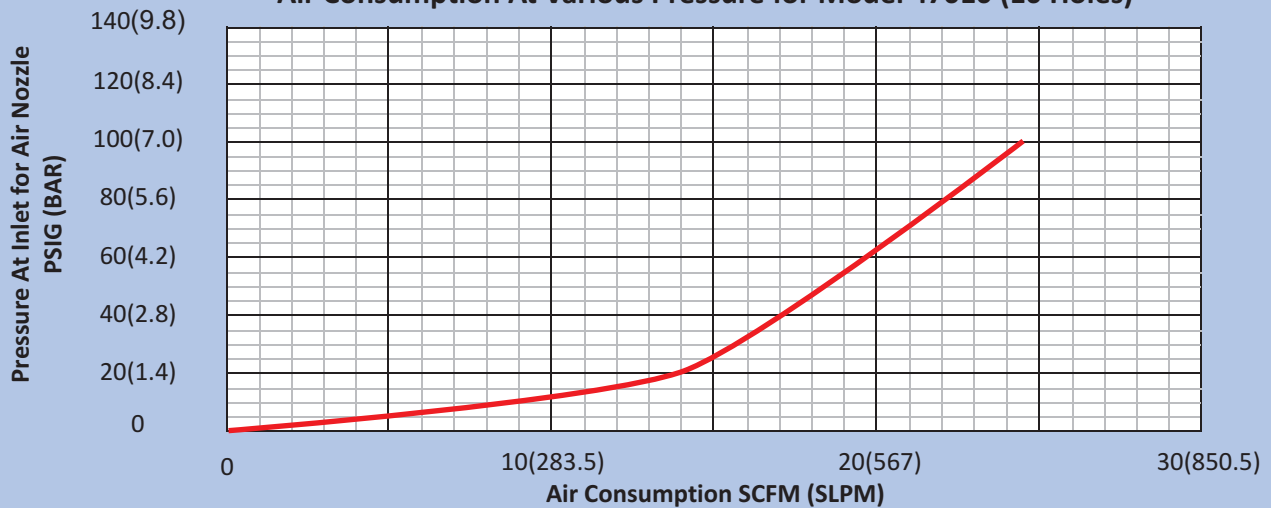

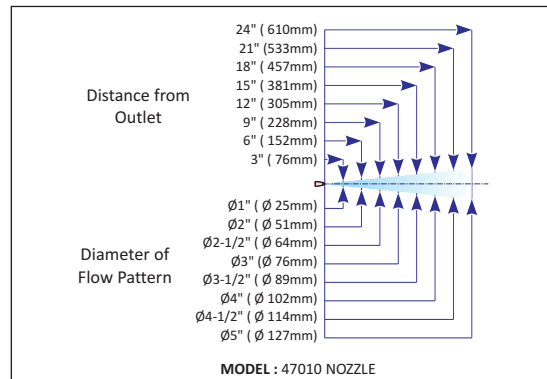
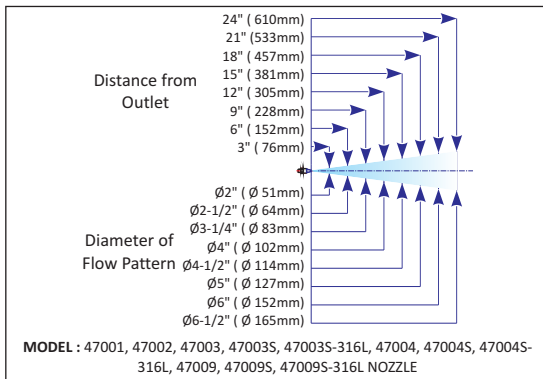
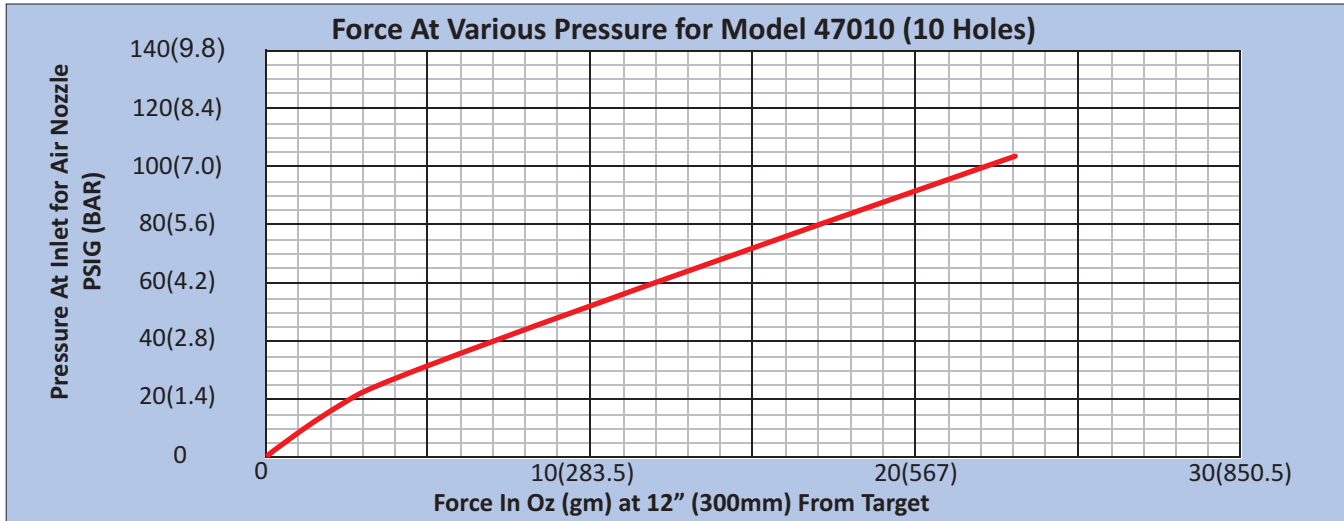

AIR NOZZLES

PART NO.	DESCRIPTION
47004AMF	Cast Zinc high force/air efficiency Air Mag™ nozzle - 1/4" female NPT or BPS
47001	Brass Mini Nozzle with 10/32 fitting or metric equivalent
47002	Brass Mini Nozzle with copper tube - male
47003	Standard Aluminum 1/8" NPT or BPS male fitting
47003S	Standard 303/304 Stainless Steel 1/8" NPT or BPS male fitting
47003S-316L	Standard 316L Stainless Steel 1/8" NPT or BPS male fitting
47004	Extra Strong Aluminum 1/4" NPT or BPS male fitting
47004S	Standard 303/304 Stainless Steel 1/4" NPT or BPS male fitting
47004S-316L	Standard 316L Stainless Steel 1/4" NPT or BPS male fitting
47009	Adjustable Aluminum Nozzle with 1/8" male NPT or BPS fitting
47009S	Standard 303/304 Stainless Steel 1/8" NPT or BPS male fitting
47009S-316L	Standard 316L Stainless Steel 1/8" NPT or BPS male fitting
47010	X-Stream™ Anodized Aluminum Strong Force Nozzle with 1/4" female NPT or BPS fitting

STAINLESS STEEL RIGID FLEX HOSE (REFER TO PAGE E9 FOR THE RIGID FLEX HOSE)

PART NO.	DESCRIPTION
6RF (MM / MF)	6" Stainless Steel Rigid Hose which can be flexed to a shape
12RF (MM / MF)	12" Stainless Steel Rigid Hose which can be flexed to a shape
18RF (MM / MF)	18" Stainless Steel Rigid Hose which can be flexed to a shape

AIR JETS:

Air Jets are larger than Nozzles and used when a wider area needs to be hit with the amplified air. They are significantly more efficient than Nozzles although often use as much compressed air. Their best use is to replace pairs of Nozzles that are used for part ejection or for blowoff applications that require greater force than that provided by Air Knives or Air Movers. Nozzles are for point use while air jets can fan out somewhat for better continuous blowoff when a row of them are made. Nex Flow™ Jets are all made adjustable with a lock ring to assure the security of any gap setting. They have a female 1/8" NPT and made lightweight with anodized aluminum.

6 models are available: From left to right is Model 45001 High Flow Air Jet, Model 45002 High Force Air Jet and Model 45003 Mini Air Jet all in anodized aluminum, the Model 45002B High Force Air Jet in brass and the Model 45002S High Force Air Jet in 316L Stainless Steel and the Model 45004 High Force Fat Air Jet Amplifier in anodized aluminum.



The **Mini Air Jet Model 45003** is ideal for small spots where a Nozzle may not be adequate for wider coverage of air flow. It is most compact air jet available with high force and adjustability. Sound level is 82 dBA at 3ft (0.91mm) at 80 psig (5.6 bar).

<p>High Flow Air Jet Model 45001</p>	<p>High Force Air Jet Model 45002, Model 45002B & Model 45002S</p>	<p>Model 45001 / 45002 / 45002B / 45002S - High Flow Air Jet are physically the same size. The only difference is a larger exit opening for the amplified air flow. The high flow system is used more for cooling and light blowoff while the high force version is used mainly for heavier blowoff applications.</p> <p>The Sound level for Model 45001 is 80 dBA and for the Model 45002/ 45002B / 45002S it is 82 dBA at 3ft (0.91mm) at 80 psig (5.6 bar).</p> <p>The 45002B Brass Air Jet and the 45002S 316L Stainless Steel Air jet are marked to indicate the size of the air gap and can be easily set and locked into place.</p> <p>*BSP Thread or adaptors can be supplied depending on country location.</p>
<p>Mini Air Jet Model 45003</p>	<p>High Force Air Jet Model 45004</p>	

Air Jets perform similar to Adjustable Air Amplifiers - with the same lock ring and methodology. Nex Flow™ Air Jets are adjustable and come with a lock ring to fix the gap.

HOW IT WORKS

Model 45001, 45002, 45002B, 45002S, 45003 and 45004

Air Jets use a small amount of compressed air entering the annular chamber and exit via small ring nozzle at high speed over a "coanda" profile. This creates a vacuum entraining outside air converting the pressure to a high flow output while maintaining a high blowoff force. Energy cost and noise levels are reduced as a result.



The **LARGE FAT Air Jet Air Amplifier** is the largest flat jet/smallest air amplifier with the same design as the high performance air jets to give you the most optimal performance with an adjustable gap and lock ring to set the gap in place.

WHAT THEY ARE – REASONS TO USE

Nex Flow™ **FAT Air Jet Air Amplifier** is made of anodized aluminum and with a fine thread for a fine and accurate adjustment of the air gap to the setting desired for any particular application.

The *Nex Flow™* **FAT Air Jet Air Amplifier** is a transition size in between an air jet and the larger air amplifiers. It provides for superior air flow amplification and high force for blow off and cooling applications.

AIR NOZZLES AND JETS

RIGID FLEX HOSE NOZZLE ACCESSORIES - TO HOLD AND AIM NOZZLES AND JETS

The unique *Nex Flow™* **RIGID FLEX** hose is an all stainless steel hose that does not break after a few bends like competitive rubber hoses with simple copper inserts. It is resistant to creep and crimping. Its all stainless construction allows it use in any difficult environment. They have 1/4" male NPT welded end connections and come in 6", 12" and 18" overall lengths.



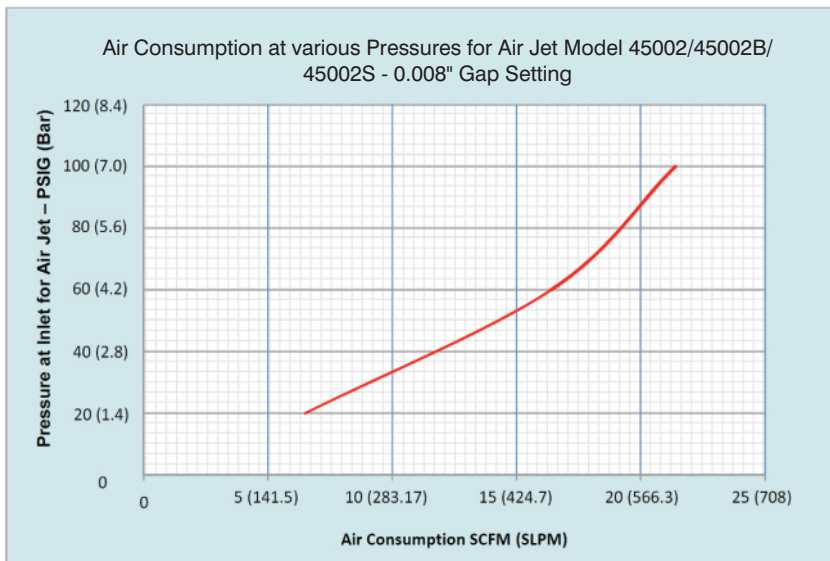
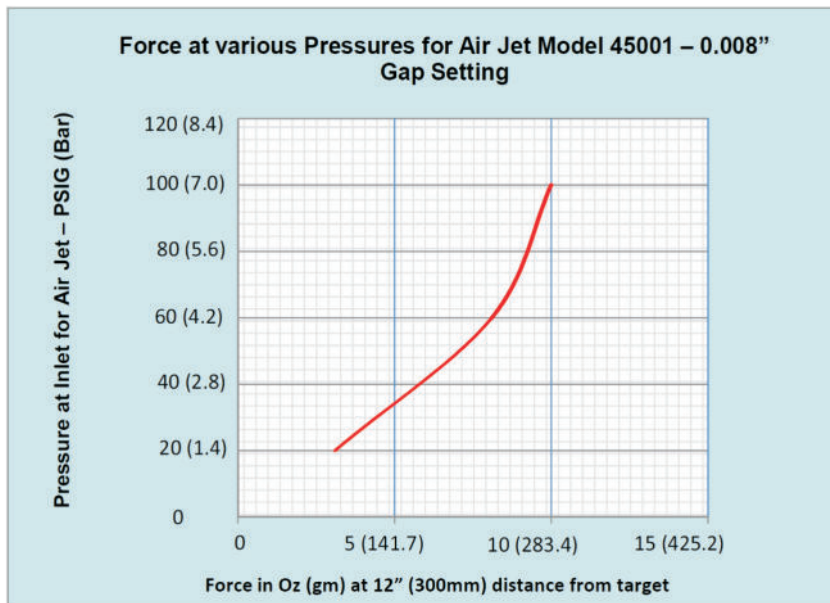
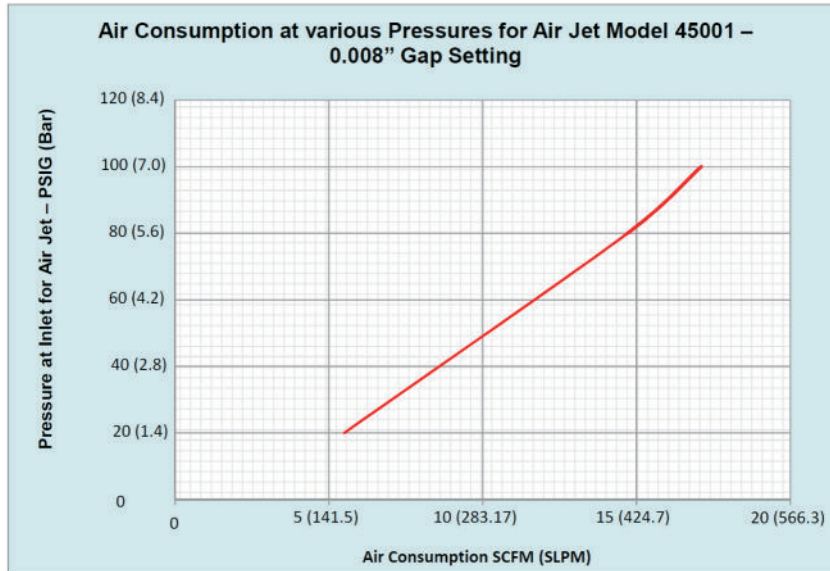

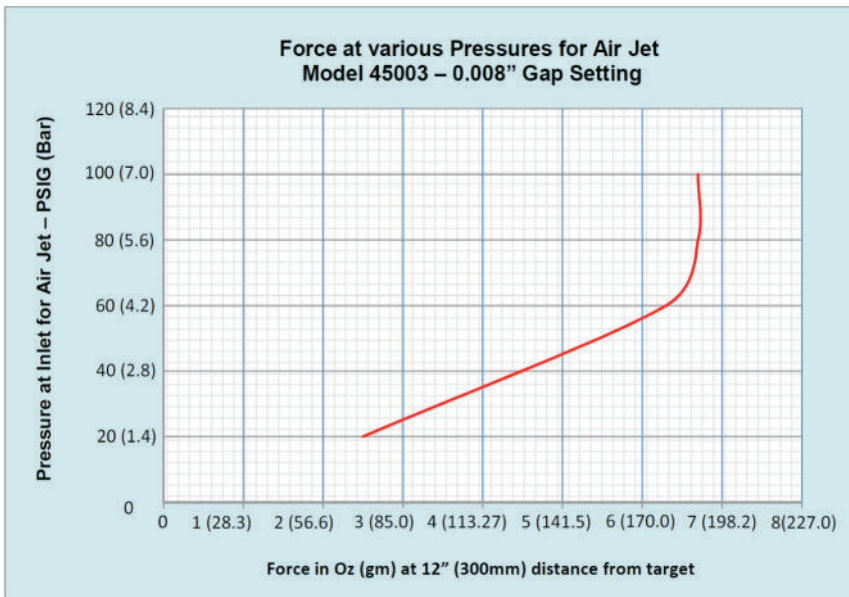
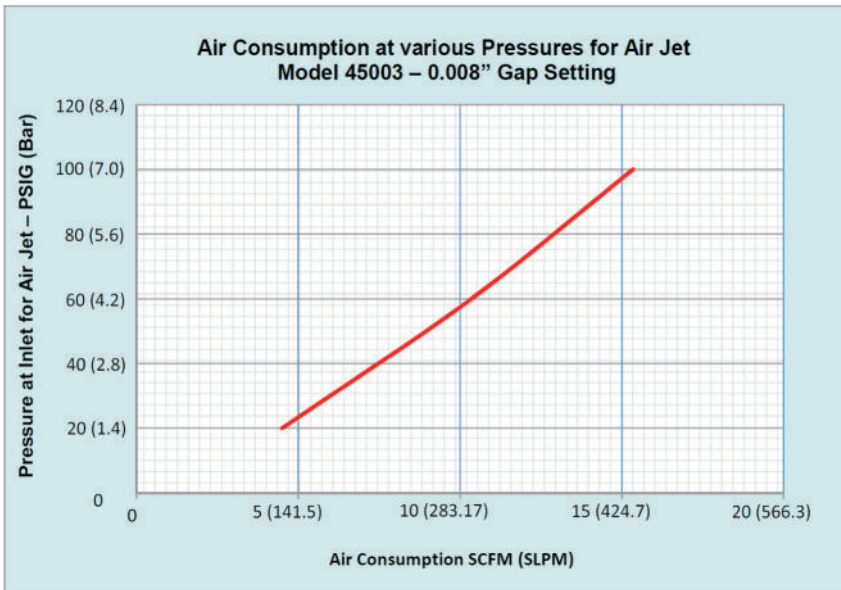
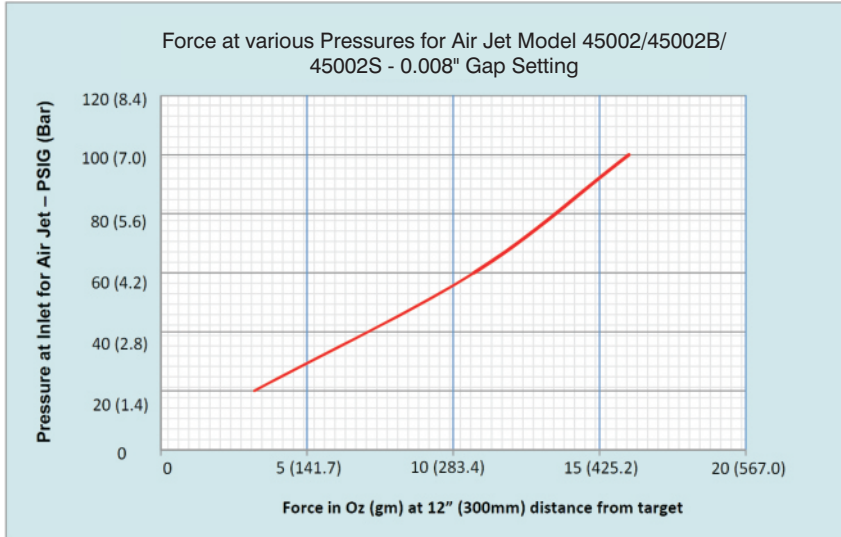

Air Consumption At Various Pressure for Air Jet Model 45004 - .004" setting.

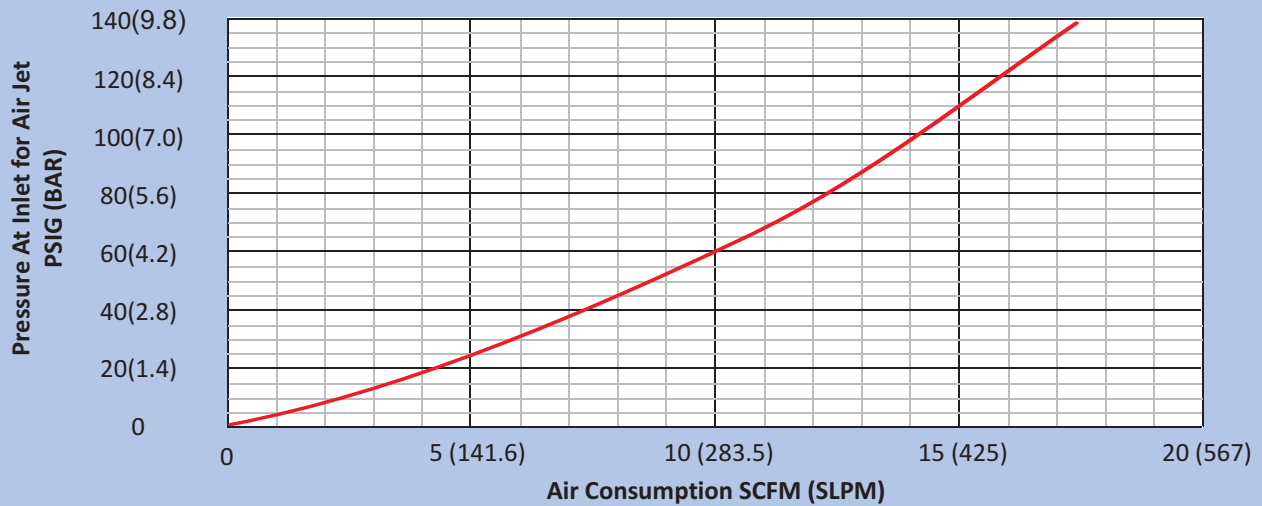

Force At Various Pressure for Air Jet Model 45004 - .004" setting.

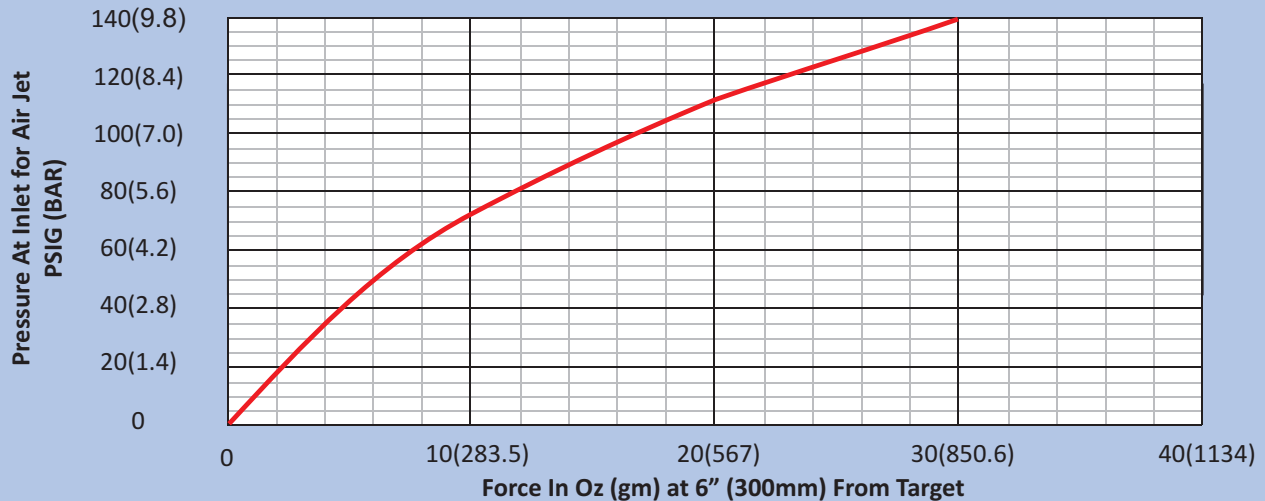

RIGID FLEX HOSE NOZZLE ACCESSORIES - TO HOLD AND AIM NOZZLES AND JETS

The unique Nex Flow™ RIGID FLEX hose is an all stainless steel hose that does not break after a few bends like competitive rubber hoses with simple copper inserts. It is resistant to creep and crimping. Its all stainless construction allows it use in any difficult environment. They have 1/4" male NPT welded end connections and come in 6", 12" and 18" overall lengths.



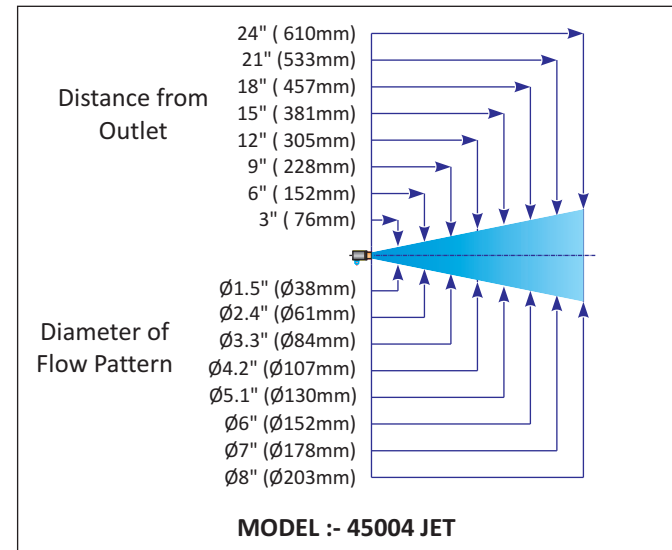
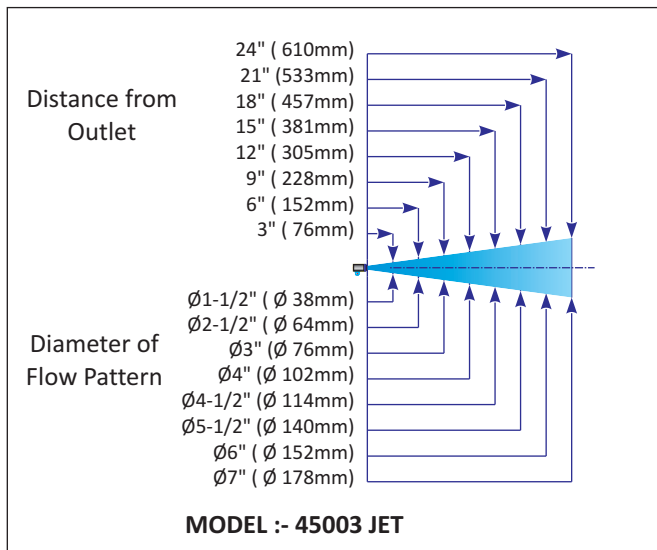
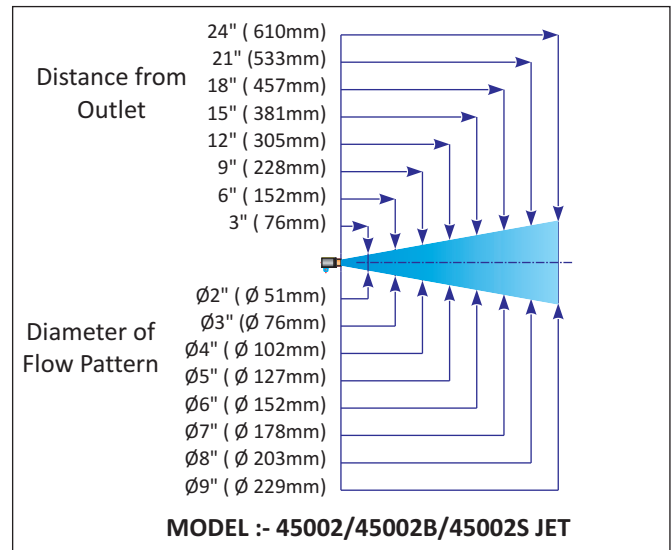
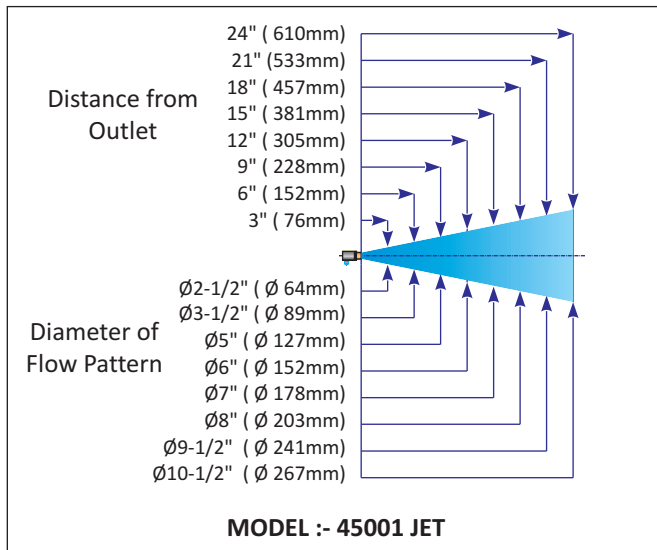

AIR JETS

PART NO.	DESCRIPTION
45001	High Flow Air Jet (aluminum, unmarked)
45002	High Force Air Jet (aluminum, unmarked)
45002B	High Force Air Jet (Brass, marked to indicate gap setting)
45002S	High Force Air Jet (316L stainless, marked to indicate gap setting)
45003	Mini - High Force Air jet
45004	Fat Air Jet Air Amplifier (aluminum, unmarked)

STAINLESS STEEL RIGID FLEX HOSE

PART NO.	DESCRIPTION
6RF (MM / MF)	6" Stainless Steel Rigid Hose which can be flexed to a shape
12RF (MM / MF)	12" Stainless Steel Rigid Hose which can be flexed to a shape
18RF (MM / MF)	18" Stainless Steel Rigid Hose which can be flexed to a shape

AIR NOZZLES AND JETS

AIR EDGER™ FLAT JET NOZZLE

Superior designed Flat Jet Nozzle reduces compressed air consumption and noise levels

– with the use of different shims can vary the force from weak to strong depending on the application

WHAT ARE THEY - REASONS TO USE

Model **47011** (cast zinc) **Air Edger™ Flat Jet** and Model **47011S-316L** (316L stainless steel) is an extremely efficient flat jet air nozzle designed to provide a powerful stream of high velocity laminar flow and high force for blow off and cooling where air knives may not be enough

When bench tested against several other flat jets, even those with special designed holes or shims, the **Air Edger™ Flat Jet** outperformed them all despite whatever claims others may make. Air consumption and noise levels are minimized with its special design and configuration.



The **Nex Flow™ Air Edger™ Flat Jet** is available with various size “gaps” all set by a flat shim. Three standard shim sizes are available - .004” (.10 mm), .008” (.2mm) and .020” (.51 mm). One, two or more shims can be “stacked” for a larger gap and greater force.

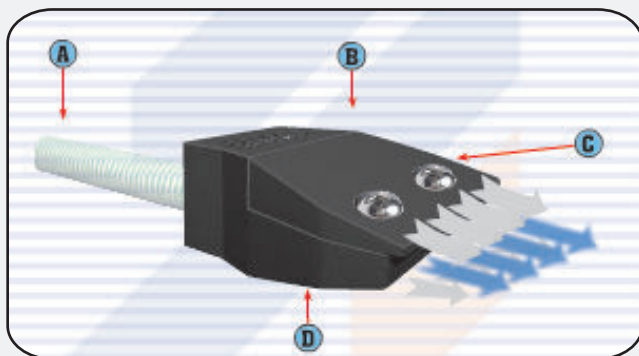

HOW IT WORKS

Compressed air enters the flat jet at the rear port at (A). Air is entrained at point (B) and (D) by the compressed air stream that leaves the flat jet from a small gap at the end. The entrained air follows the profile that directs the airflow in a perfect straight line to create a uniform sheet of air along the 2” length of the Air Edger™ Flat Jet Nozzle. The amplified air stream maximizes velocity and force to produce a well-defined sharp edge laminar flow with minimal wind shear for reduced energy use in blow off and cooling. Two screws at (C) allow you to vary the gap with a variety of sizes of shims (.004”, .008” or .020”). One or two shims may be used.



Air Edger™ Flat Jet with .008” gap setting blows water from under the caps on a bottling line moving at high speed



Air Edger™ Flat Jet with .020” gap setting provides a powerful force to blow off dirt and debris in an extrusion line

PERFORMANCE

AIR CONSUMPTION AND FORCE

MODEL Cast Aluminum	MODEL 316L Stainless	SCFM (SLPM) at 80 PSIG Measured at entrance to jet	FORCE in Ounces (grams) at 12" from target
Model 47011-4	Model 47011S-316L-4	20.5 (581)	12 (340)
Model 47011-8	Model 47011S-316L-8	31.3(887)	21 (595)
Model 47011-12	Model 47011S-316L-12	38.5 (1091)	27 (765)
Model 47011-16	Model 47011S-316L-16	41.0 (1161)	30 (850)
Model 47011-20	Model 47011S-316L-20	44.5 (1261)	33 (936)
Model 47011-24	Model 47011S-316L-24	47.0 (1331)	36(1020)
Model 47011-28	Model 47011S-316L-28	51.0 (1445)	39 (1106)

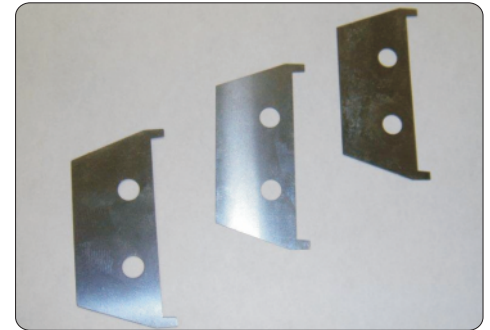

The Air Edger™ Flat Jet Nozzle air gap is set by one or more shims. There are three basic shim sizes - .004" (.1 mm), .008" (.2 mm) and .020" (.5 mm). Shims may be stacked for larger gaps and for sizes in between the shim standard sizes offered. Shims available in both 304 stainless steel & 316L stainless (for the stainless Air Edger™). The greater the gap the more powerful the force.

DIMENSIONS

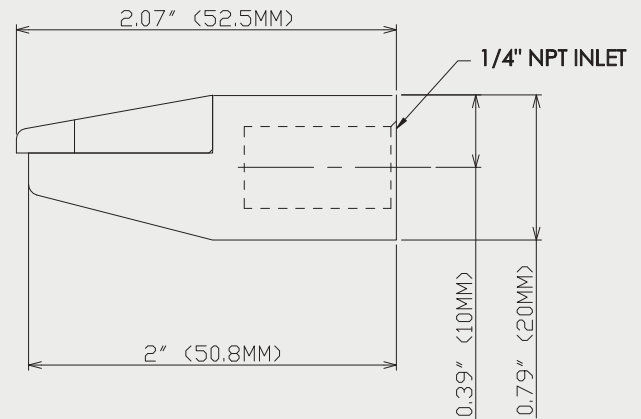
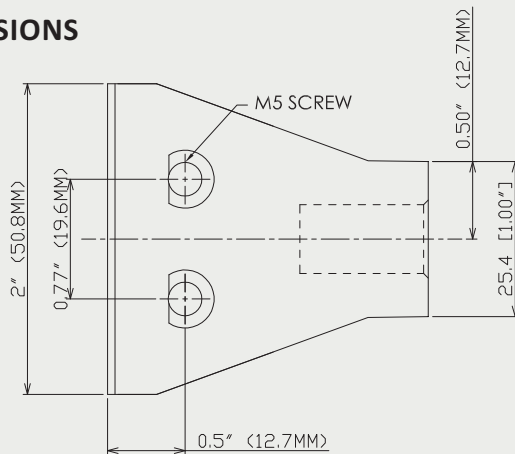

COMPARED TO COMPETITION

It is not always clear how tests and measurements are made by competitors and therefore validating claims can be difficult since such values depend on how tests are done. Therefore we measured a competitive unit under the same conditions as we measured our units. The flat jet of the competitor is of a similar type except that they are using a saw tooth shim design and different internal dimensions. We obtained the following readings when measured using the same parameters as for Nex Flow units.

25.1 SCFM AIR CONSUMPTION AND 15 oz force
(Published figures were 22 SCFM and 22 oz force)

One measure of efficiency is the ratio of Force/Air Consumption. The higher the ratio the better the efficiency. The force/SCFM is a ratio of .54 based on measured figures when measured the same way as the Nex Flow units.

If we compare to that of the Nex Flow Model 47011-4 the ratio is 12/20.5 = .58 And for the Model 47011-8 the ratio is 21/31.3 = .67

In both cases the efficiency of the Nex Flow units are higher in the comparative tests done under the same conditions.

FLAT JET NOZZLES	
PART NO.	DESCRIPTION
47011-4 & 47011S-316L-4	Air Edger™ Flat Jet with .004" gap setting
47011-8 & 47011S-316L-8	Air Edger™ Flat Jet with .008" gap setting
47011-12 & 47011S-316L-12	Air Edger™ Flat Jet with .012" gap setting
47011-16 & 47011S-316L-16	Air Edger™ Flat Jet with .016" gap setting
47011-20 & 47011S-316L-20	Air Edger™ Flat Jet with .020" gap setting
47011-24 & 47011S-316L-24	Air Edger™ Flat Jet with .024" gap setting
47011-28 & 47011S-316L-28	Air Edger™ Flat Jet with .028" gap setting
47111S-4	.004" 304 stainless steel shim
47111S-8	.008" 304 stainless steel shim
47111S-20	.020" 304 stainless steel shim
47211S	304 stainless steel shim set – Two (2) .004", Two (2) .008" and One (1) .020" shim
47111S-316L-4	.004" 316L stainless steel shim
47111S-316L-8	.008" 316L stainless steel shim
47111S-316L-20	.020" 316L stainless steel shim
47211S-316L	316L stainless steel shim set – Two (2) .004", Two (2) .008" and One (1) .020" shim

NOT SURE OF THE SIZE YOU NEED?

If you are not sure of which level of power you need, we recommend a Model 47211S Shim Set (for the cast zinc model) or a Model 47211S-316L Shim Set (for the 316L stainless steel model). The shim set consists of 2 - .004" shims, 2 - .008" shims and 1 - .020" shim and any two shims (or more) can be stacked to set the gap best suited to your application.

RIGID FLEX HOSE NOZZLE ACCESSORIES - TO HOLD AND AIM NOZZLES AND JETS



The unique Nex Flow™ RIGID FLEX hose is an all stainless steel hose that does not break after a few bends like competitive rubber hoses with simple copper inserts. It is resistant to creep and crimping. Its all stainless construction allows it use in any difficult environment. They have ¼" male NPT welded end connections and come in 6", 12" and 18" overall lengths.



STAINLESS STEEL RIGID FLEX HOSE (REFER TO PAGE M5 FOR THE RIGID FLEX HOSE)	
PART NO.	DESCRIPTION
6RF (MM / MF)	6" Stainless Steel Rigid Hose which can be flexed to a shape
12RF (MM / MF)	12" Stainless Steel Rigid Hose which can be flexed to a shape
18RF (MM / MF)	18" Stainless Steel Rigid Hose which can be flexed to a shape