

SILENT X-STREAM™ AIR BLADE™ AIR KNIFE

Blowoff, clean, cool and dry with this quiet, sharp and strong focused curtain of air



WHAT ARE THEY - REASONS TO USE

The Silent X-Stream™ Air Blade™ Air Knife is easy to mount and maintain, reducing both compressed air consumption and noise levels. It is the most efficient design yet achieved in Air Knife blow off technology in reducing noise levels and air consumption yet providing the optimum in blow off energy.

The Silent X-Stream™ Air Blade™ Air Knife produces a "laminar" flow of air along its length using the "Coanda" effect which "entrains" a large volume of air from the surrounding area along with a small amount of compressed air from the X-Stream™ Air Blade™ Air Knife to produce an output flow up to 40 times.

System payback on compressed air savings can be as soon as a few weeks in some applications.

The Silent X-Stream™ Air Blade™ Air Knife comes in three versions: Gold Anodized Aluminum for most applications, Hard Anodized aluminum for abrasive environments or where material may come in contact and tend to wear against the air knife, and stainless steel for high temperature and corrosive environments.

NOTE: Plastic shims can wear out quickly in Air Knives if the air is not clean. Nex Flow™ uses ONLY stainless steel shims.



Available in Hard Anodized aluminum for abrasive environments or where material may come in contact with the air knife.

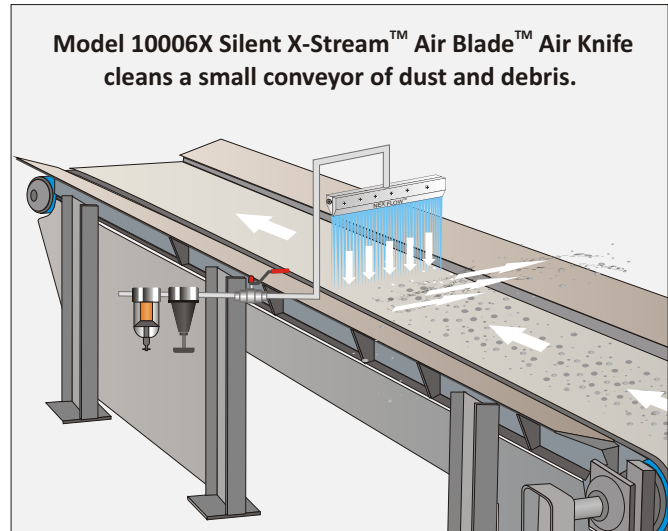

Model 10006X Silent X-Stream™ Air Blade™ Air Knife cleans a small conveyor of dust and debris.

SILENT X-STREAM™ AIR BLADE™ AIR KNIFE FEATURES:

- ▶ No moving parts - Gold Anodized aluminum, Hard Anodized aluminum or stainless steel.
- ▶ Compact design, simple, lightweight and portable.
- ▶ Full flow - Air across entire length of Air Knife.
- ▶ Air inlets at ends and back.
- ▶ Driven by air not electricity.
- ▶ Replaces drilled pipe and open jets or nozzles used for blowoff, cleaning, drying and cooling.
- ▶ High airflow amplification.
- ▶ Instant on-off, no electricity or explosion hazard.

SILENT X-STREAM™ AIR BLADE™ AIR KNIFE BENEFITS:

- ▶ Longer life in difficult environments than competitive models.
- ▶ Lower compressed air consumption than drilled pipe or rows of open jets and nozzles.
- ▶ Can be placed end to end for continuous airflow.
- ▶ Maintenance free with output easily controlled, safe to use.

SILENT X-STREAM™ AIR BLADE™ AIR KNIFE ADVANTAGES OVER BLOWERS:

- ▶ Compact design, simple, lightweight and portable.
- ▶ Driven by air, not electricity for safety.
- ▶ No moving parts - Hence safer and maintenance free.
- ▶ Lower noise levels at 69 dBA and less with smaller space.



SILENT X-STREAM™ AIR BLADE™ AIR KNIFE APPLICATIONS:

- ▶ Cleaning of steel sheet in strip mills
- ▶ Parts drying
- ▶ Cleaning or drying web processes.
- ▶ Pre-paint drying and blowoff
- ▶ Scrap removal
- ▶ Parts cooling
- ▶ Circuit board cooling
- ▶ Use for environment separation with air curtain effect
- ▶ Opening bags for filling
- ▶ Sheet separation

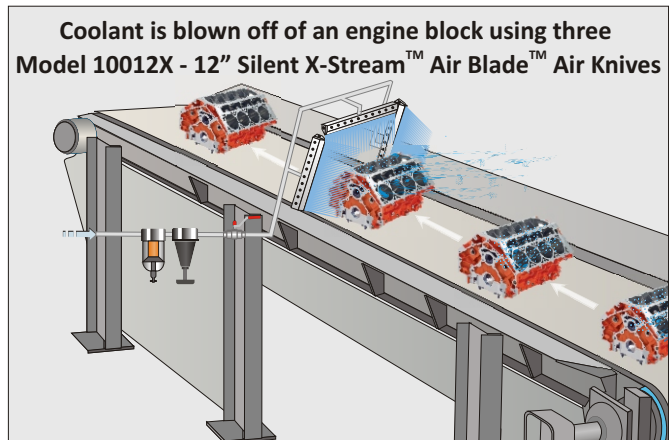

SILENT X-STREAM™ AIR BLADE™ AIR KNIFE VERSES OTHER BLOWOFF PRODUCTS:

1. **Drilled Pipe** - Typically drilled pipe uses more compressed air while producing inconsistent flow at high noise levels. The Silent X-Stream™ Air Blade™ Air Knife can usually cut air costs as much as 50%.
2. **Flat Air Nozzles** - These products can use even more compressed air than drilled holes with the same problems of inconsistent flow at high noise levels.
3. **Air Blowers** are capital intensive but can use less energy than compressed air operated air knives on a continual basis. However blowers cannot be cycled on and off quickly and can actually use the same or more energy in intermittent applications. Choosing a blower or Silent X-Stream™ Air Blade™ Air Knife depends on the following factors:
 - (A) **Availability of a particular energy source** - is electricity or air the most convenient.
 - (B) **Space and Weight** - These are important factors that affect the overall cost and maintenance of a system. The compressed air operated Air knife is light weight and compact.
 - (C) **Noise level** - The Silent X-Stream™ Air Blade™ Air Knife is intrinsically quiet while blower systems are noisy and require costly silencing.
 - (D) **Application particulars** - The specific application often determines what is best to use. Intermittent blowoff and/or tight spaces favor the use of the Silent X-Stream™ Air Blade™ Air Knife.
 - (E) **Reliability** - Blower systems require maintenance because they have moving parts. The Silent X-Stream™ Air Blade™ Air Knife requires no maintenance when properly filtered and is intrinsically the most reliable.
 - (F) **Energy Cost** - Energy cost can be less with a blower system especially on continuous blowoff applications. However, energy cost can often be offset against higher capital costs and maintenance costs when utilizing blower systems. The Silent X-stream™ Air Blade™ Air Knife is low cost with negligible maintenance.
 - (G) **System Cost** - Much higher for blower systems especially if silencing is required. It is low for Silent X-Stream™ Air Blade™ Air Knives.
 - (H) **Maintenance and Operating Cost** - The need for maintenance of blower systems can be a strong negative in some situations, especially if the blowers or electrical systems are in harsh environments. The Silent X-Stream™ Air Blade™ Air Knife however is resilient to harsh environments in comparison

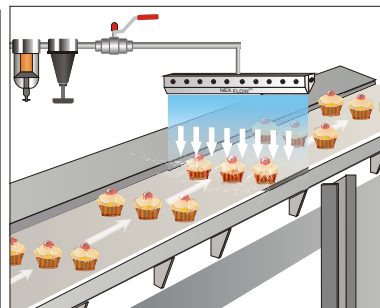
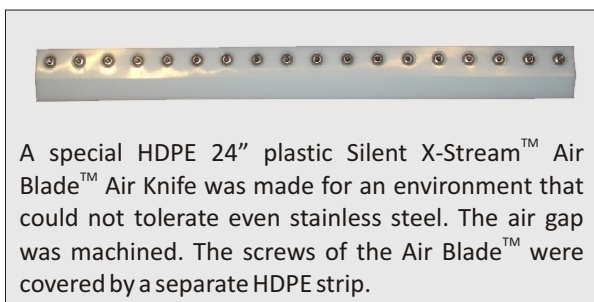

A stainless steel 36" Silent X-Stream™ Air Blade™ Air Knife blows off excess sugar from muffins prior to the oven to avoid burning. A Model 90009 Regulator with gauge sets the ideal pressure and flow.

SILENT X-STREAM™ AIR BLADE™ AIR KNIFE - HOW IT WORKS:

Silent X-Stream™ Air Blade™ Air Knife - Compressed air enters the Air Knife at the rear (or end) ports at (A). Air is entrained at point (B) and (D) by the compressed air stream that leaves the Air Knife from a small gap at point (C). The entrained air follows the profile that directs the airflow in a perfect straight line to create a uniform sheet of air along the entire length of the Air Blade™ Air Knife. The amplified air stream maximizes velocity and force is maintained as a well defined sheet of laminar flow with minimal wind shear for reduced energy use in blowoff and cooling.

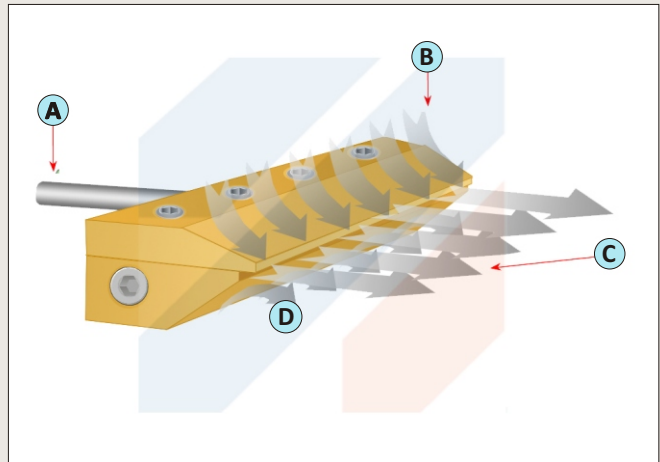

X-Stream™ Air Blade™ Air Knife is available in Eleven standard lengths in anodized aluminum and in Nine lengths in stainless steel: 2" (51 mm), 3" (76 mm), 6" (150 mm), 9" (229 mm), 12" (300 mm), 18" (457 mm), 24" (609.5 mm), 30" (761 mm), 36" (914 mm), and in aluminum only 42" (1066.8 mm) and 48" (1219.2 mm)

GOLD ANODIZED AND HARD ANODIZED ALUMINUM SILENT X-STREAM™ AIR BLADE™ AIR KNIFE

6" to 54" X-STREAM™ AIR BLADE™ AIR KNIVES ARE SUPPLIED WITH ADDITIONAL FLUSH PLUGS FOR THE UNUSED INLET PORTS

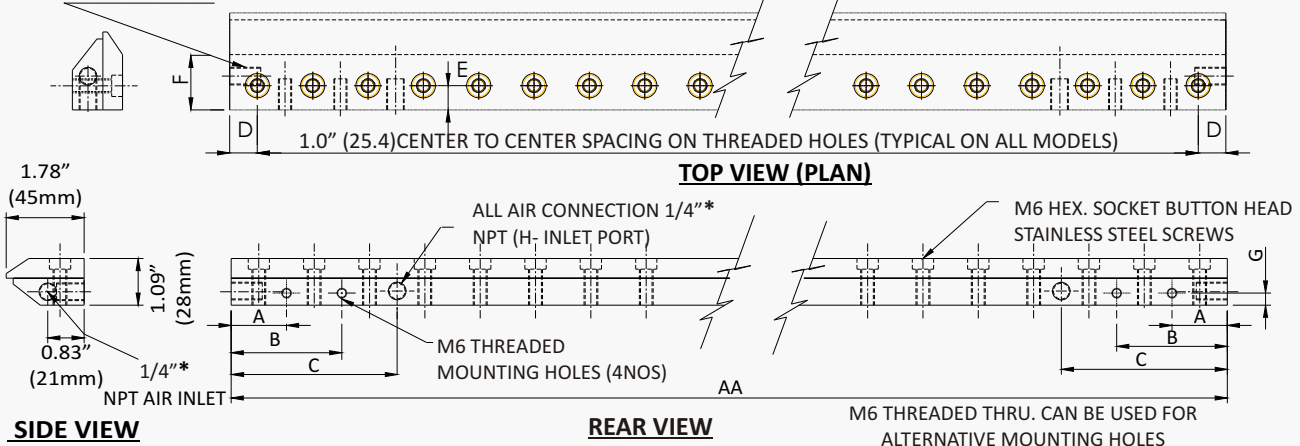

STAINLESS STEEL SILENT X-STREAM™ AIR BLADE™ AIR KNIFE

6" TO 36" X-STREAM™ AIR BLADE™ AIR KNIVES ARE SUPPLIED WITH ADDITIONAL FLUSH PLUGS FOR THE UNUSED INLET PORTS

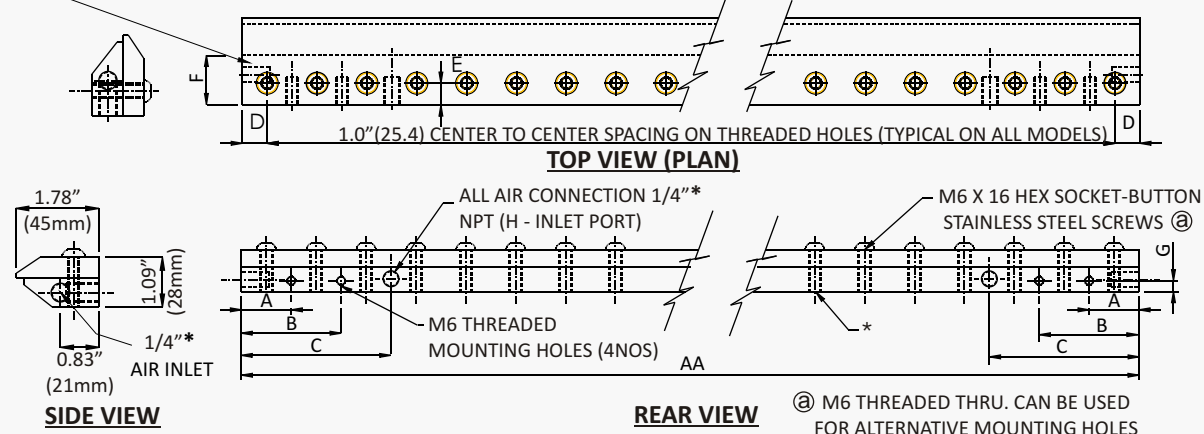

(* BSP Threads or Adaptors can be supplied depending on country location)